

AUFLAGESEITE

SENKRECHTER SCHNITT oben

Kunde		ZUANI DEUTSCHLAND rif. PAULI			
Title		HOLZ/ALU Fensterschnitt IV 78/78			
Revis.	A.P.	Date	15-05-2012	Scala	1:1
Verif.	M.Z.	Date	12-12-2011	Dis.	M.Z.
		Date	12-12-2011	Codice Dis.N°	A7878D00.112

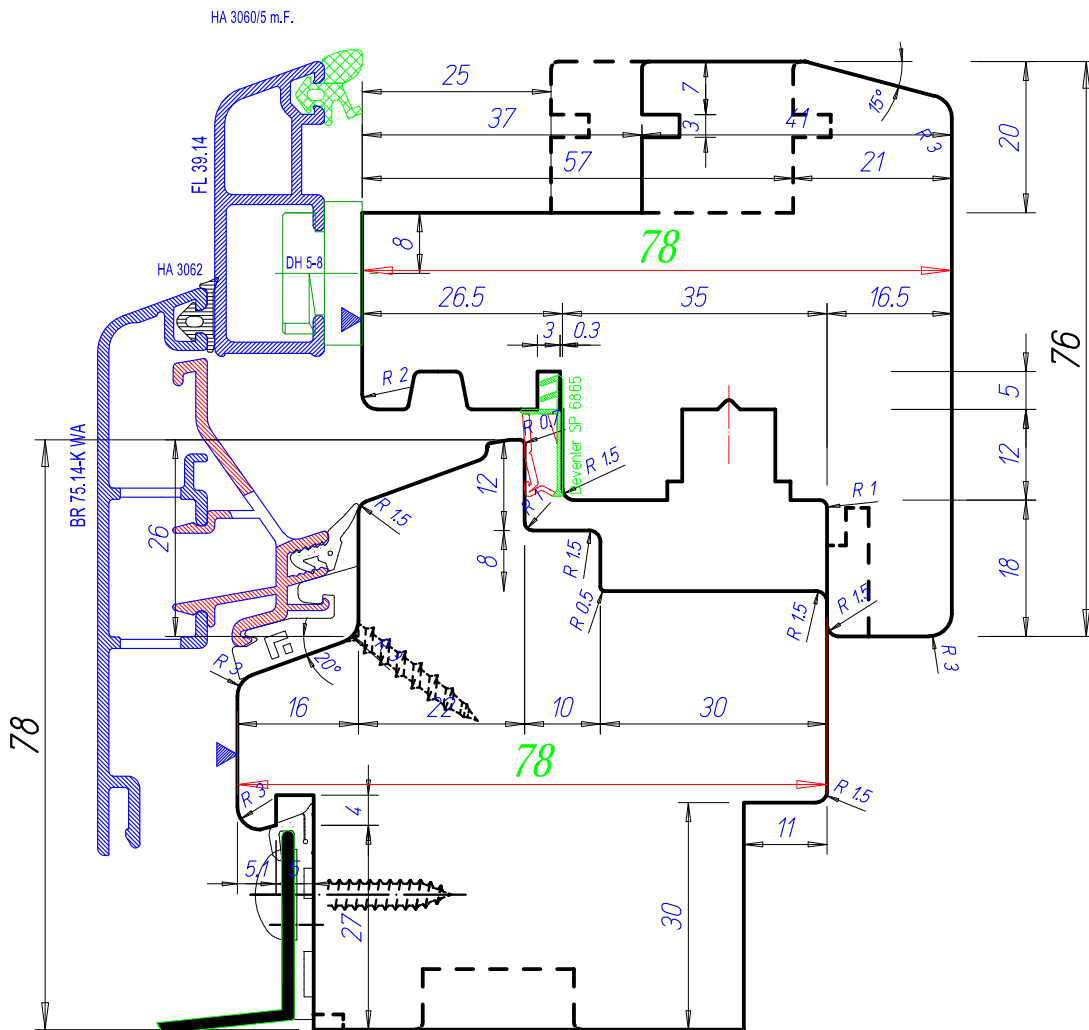
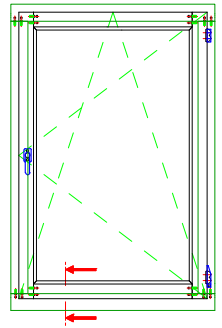

AUFLAGESEITE

SENKRECHTER SCHNITT unten

Kunde		ZUANI DEUTSCHLAND rif. PAULI			
Title		HOLZ/ALU Fensterschnitt IV 78/78			
Revis.	A.P.	Date	15-05-2012	Scala	1:1
Verif.	M.Z.	Date	12-12-2011	Dis.	M.Z.
		Date	12-12-2011	Codice Dis.N°	A7878D00.112

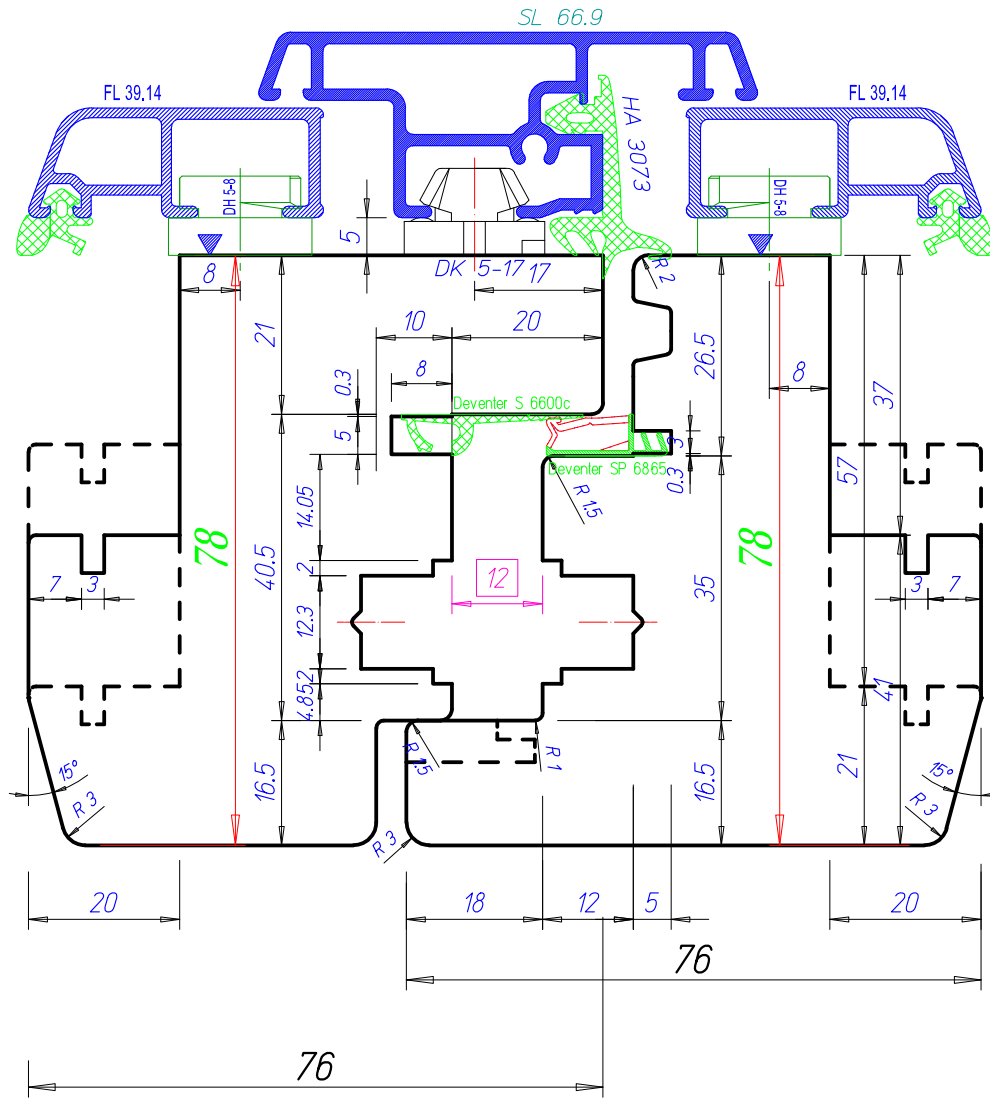
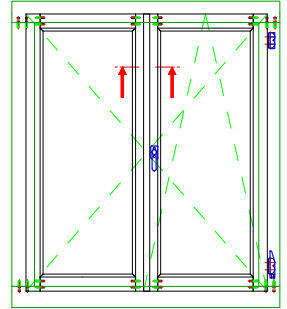

AUFLAGESEITE

WAAGERECHTER SCHNITT - Mittelfalz ohne Überfäzung

Kunde		ZUANI DEUTSCHLAND rif. PAULI			
Title		HOLZ/ALU Fensterschnitt IV 78/78			
Revis.	A.P.	Date	15-05-2012	Scala	1:1
Verif.	M.Z.	Date	12-12-2011	Dis.	M.Z.
		Date	12-12-2011	Codice Dis.N°	A7878D00.112

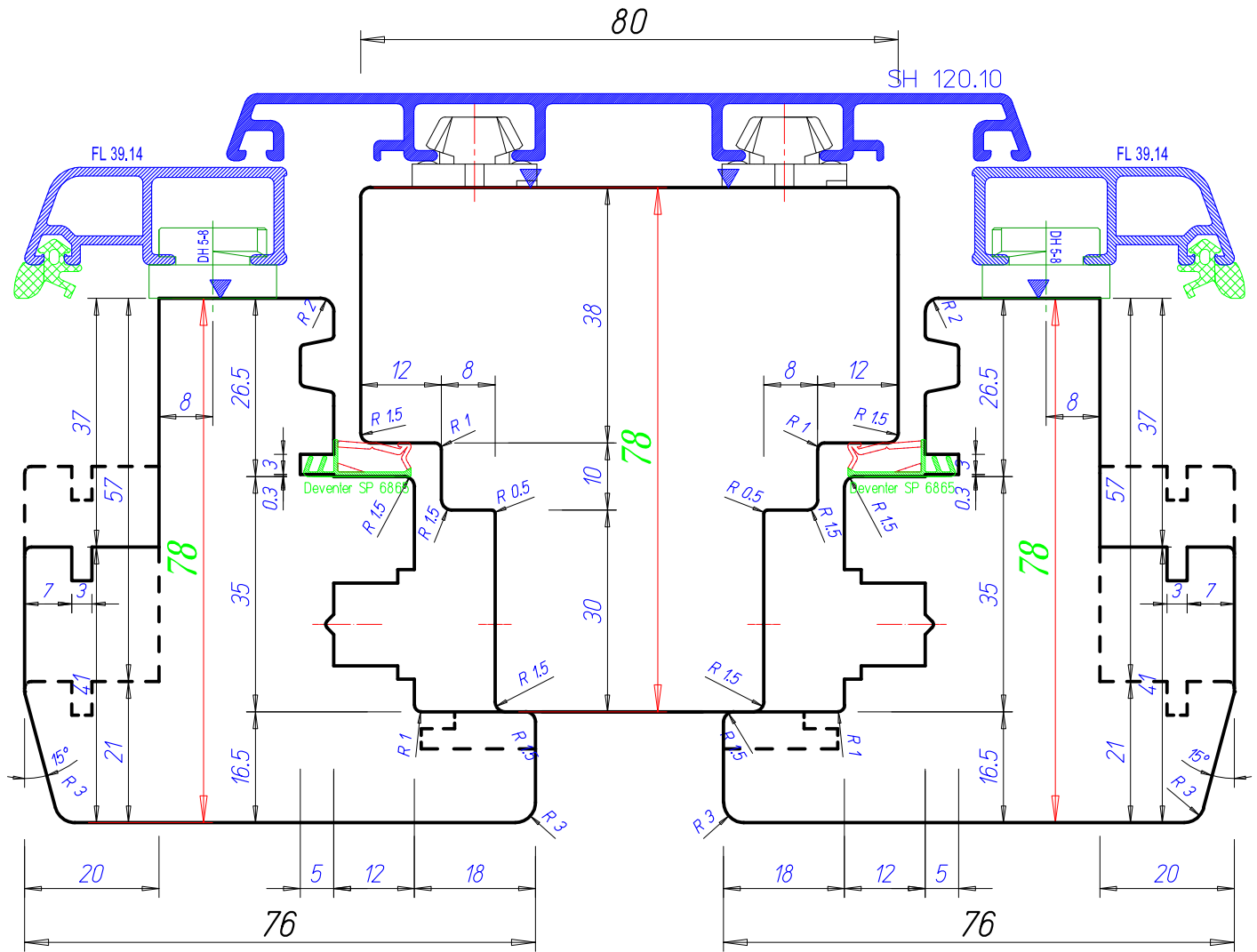
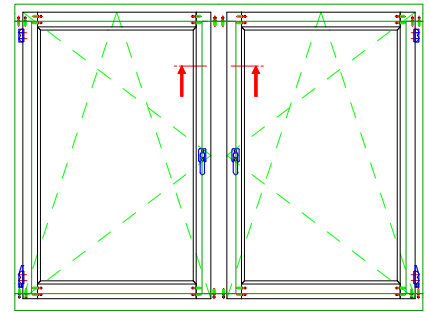

AUFLAGESEITE

WAAGERECHTER SCHNITT - SETZHOLZ

Kunde		ZUANI DEUTSCHLAND rif. PAULI			
Title		HOLZ/ALU Fensterschnitt IV 78/78			
Revis.	A.P.	Data	15-05-2012	Scala	1:1
Verif.	M.Z.	Data	12-12-2011	Dis.	M.Z.
				Codice Dis.N°	A7878D00.112
				Date	12-12-2011

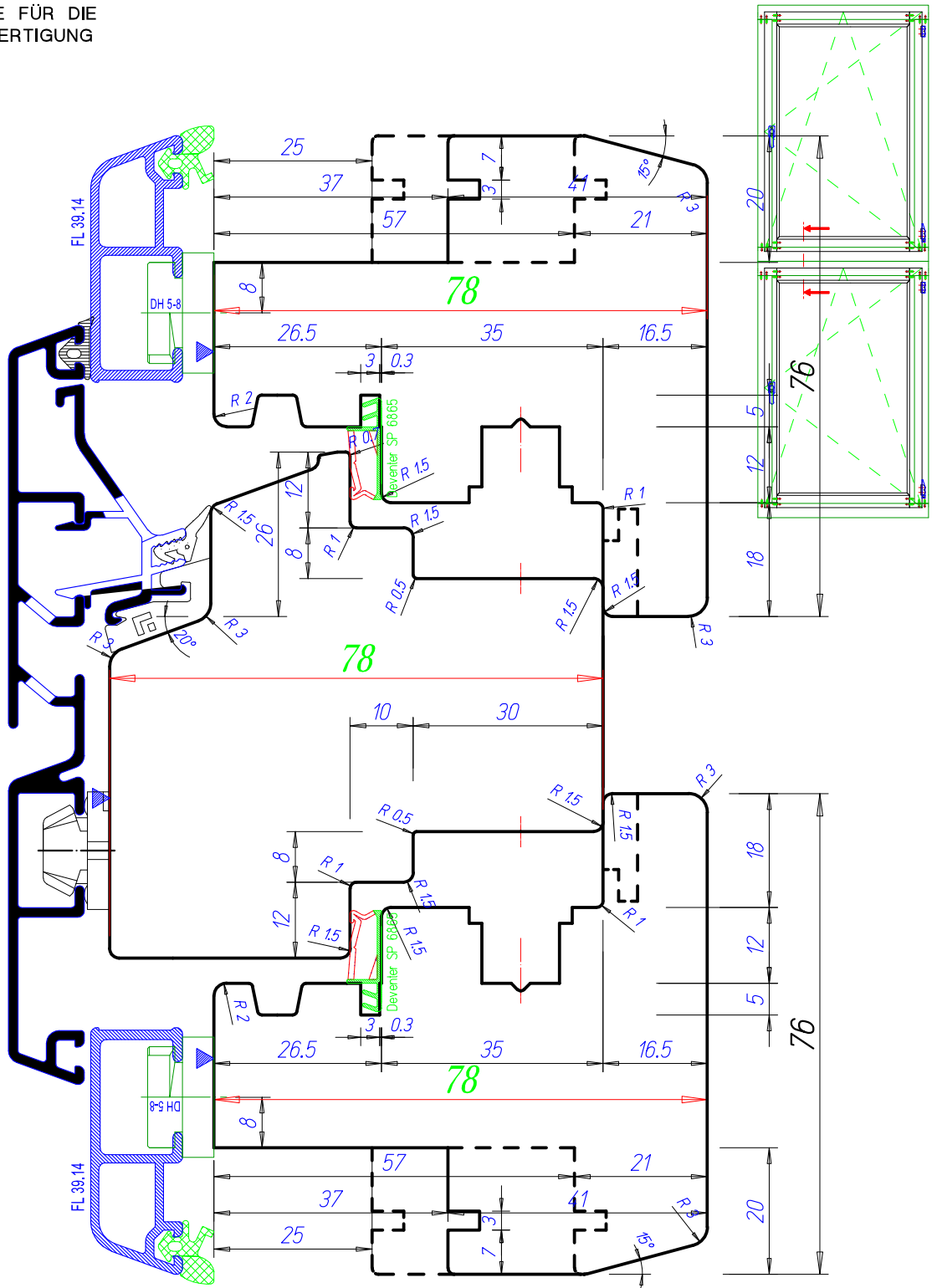

AUFLAGESEITE

WAAGERECHTER SCHNITT - KÄMPFER

Kunde		ZUANI DEUTSCHLAND rif. PAULI			
Title		HOLZ/ALU Fensterschnitt IV 78/78			
Revis.	A.P.	Date	15-05-2012	Scala	1:1
Verif.	M.Z.	Date	12-12-2011	Dis.	M.Z.
		Date	12-12-2011	Codice	A7878D00.112
				Dis.N°	A7878D00.112